

REVISIONS			
REV.#	DESCRIPTION	DATE	BY

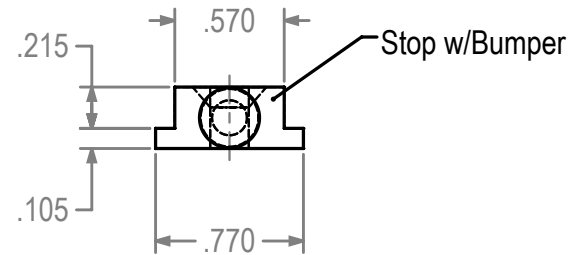
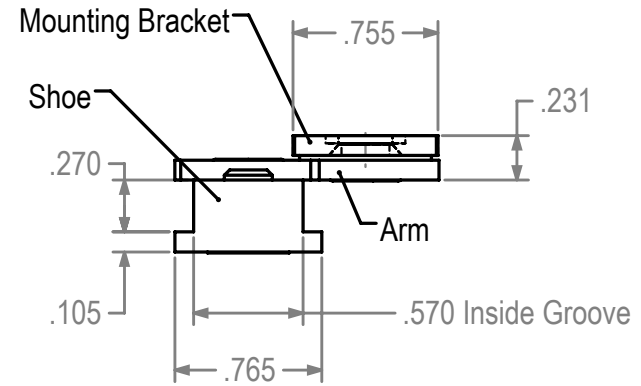
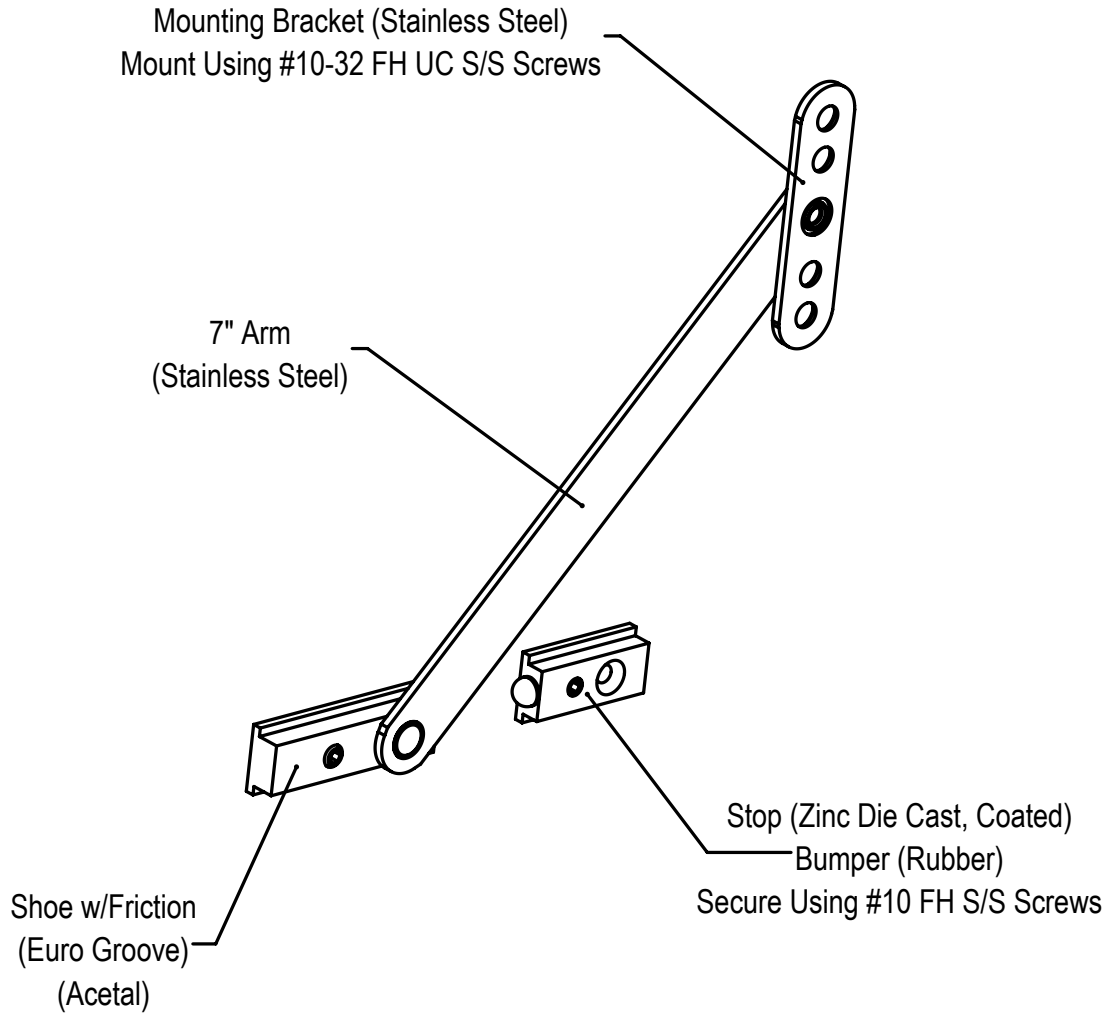

Dimensions Are For Reference Purposes Only

1614 Euro Groove Friction Adjuster

Solutions That Set New Standards			
CALDWELL		Since 1888	
Manufacturing Company 2605 Manitou Road, Rochester, New York			
TITLE		(ADV)	
1614 Euro Groove Friction Adjuster			
THIRD ANGLE PROJECTION	DRAWN HV	DATE 8/11/14	
	CHECKED	DATE	
	APPROVED	DATE	
A	EX NO	DWG NO	REV
SIZE		1614 twc	0
SCALE 1:1	SHEET 1 OF 1		